

# Diaphragm pressure gauge For the process industry

## Models 432.50, 433.50, up to 10-fold overload safety, max. 40 bar

WIKA data sheet PM 04.03



for further approvals see  
page 2

### Applications

- For measuring points with increased overload
- With liquid-filled case suitability for high dynamic pressure loads and vibrations (model 433.50)
- For gaseous, liquid and aggressive media, also in aggressive environments
- With the open connecting flange option also for contaminated and viscous media
- Process industry: Chemical, petrochemical, power plants, mining, on-/offshore, environmental technology, machine building and general plant construction

### Special features

- Case and wetted parts from stainless steel
- Wide choice of special materials
- High overload safety up to the 10-fold full scale value
- Process connection thread or open flange
- Scale ranges from 0 ... 16 mbar

### Description

Diaphragm pressure gauges are preferably used for low pressure ranges. Through the large working surface of the circular, corrugated diaphragm element, small pressure ranges can be measured reliably.

The model 432.50 diaphragm pressure gauge is manufactured in accordance with EN 837-3. The high-quality design is particularly suitable for applications in the chemical and petrochemical industry, oil and gas industry and power engineering.

The case and wetted parts from stainless steel fulfil high requirements for resistance against aggressive media. For especially high resistance requirements, the pressure chamber can, as an option, be designed with a wide variety of special materials such as PTFE, tantalum or Hastelloy.



Diaphragm pressure gauge model 432.50

For the measurement of highly viscous, crystallising or contaminated media, the use of an open connecting flange is recommended. The open connecting flange has the advantage over a threaded connection that the pressure port cannot become blocked. With an additional flushing connection on the open connecting flange, the pressure chamber can be easily cleaned.

Measuring systems with diaphragm elements, on the grounds of their design, offer good protection from overpressure, since the diaphragm can support itself against the upper flange. As standard, the model 432.50 diaphragm pressure gauge already features an overload safety of 5 times the full scale value. Optionally, higher overload safeties can be realised.

## Specifications

### Design

EN 837-3

### Nominal size in mm

100, 160

### Accuracy class

1.6

### Scale ranges

0 ... 16 mbar to 0 ... 250 mbar (flange Ø 160 mm)  
0 ... 400 mbar to 0 ... 25 bar (flange Ø 100 mm)  
or all other equivalent vacuum or combined pressure and vacuum ranges

### Pressure limitation

Steady: Full scale value  
Fluctuating: 0.9 x full scale value

### Overload safety

5 x full scale value, however max. 40 bar

### Permissible temperature

Ambient: -20 ... +60 °C  
Medium: +100 °C maximum  
Storage: -40 ... +70 °C  
(scale ranges ≤ 60 mbar: -20 ... +70 °C)

### Temperature effect

When the temperature of the measuring system deviates from the reference temperature (+20 °C): max. ±0.8 %/10 K of the span

### Ingress protection per IEC/EN 60529

Model 432.50: IP54  
Model 433.50: IP65 (with liquid filling)

### Process connection with lower measuring flange

Stainless steel 316L, G ½ B (male), SW 22

### Pressure element

≤ 0.25 bar: Stainless steel 316L  
> 0.25 bar: NiCr-alloy (Inconel)

### Pressure chamber sealing

FPM/FKM

### Movement

Stainless steel

### Dial

Aluminium, white, black lettering

### Pointer

Aluminium, black

### Case with upper measuring flange

Stainless steel, with blow-out device  
Instruments with liquid filling with compensating valve to vent case

### Window

Laminated safety glass

### Ring

Bayonet ring, stainless steel









### Filling liquid (for model 433.50)

Glycerine-water mixture

## Options

- Other process connection
- Sealings (model 910.17, see data sheet AC 09.08)
- Safety version (model 43x.30)
- Wetted parts from stainless steel, pressure chamber sealing from FPM/FKM (model 432.12)
- Overload safety: 10 x full scale value, max. 40 bar
- Vacuum safe to -1 bar
- Max. medium temperature +200 °C
- Permissible ambient temperature -40 ... +60 °C (silicone oil filling)
- Higher indication accuracy, class 1.0
- Open connecting flanges per DIN/ASME from DN 15 to DN 80 (preferred nominal widths DN 25 and 50 or DN 1" and 2" per data sheet IN 00.10)
- Wetted parts lined/coated with special materials such as PTFE (model 45x.50), Hastelloy, Monel, nickel, tantalum, titanium, silver (accuracy class 2.5, overload safety on request)
- Diaphragm pressure gauge with switch contacts, see model PGS43.1x0, data sheet PV 24.03
- Pressure gauge with output signal, see model PGT43.1x0, data sheet PV 14.03

## Approvals

Logo	Description	Country
	<b>EU declaration of conformity</b> ATEX directive (option) Hazardous areas - Ex c Zone 1 gas II 2 G c IIC TX X (for instruments without PTFE lining) II 2 G c IIB TX X (for instruments with PTFE lining) Zone 21 dust II 2 D c TX X	European Union
	<b>EAC (option)</b> ■ Pressure equipment directive ■ Hazardous areas	Eurasian Economic Community
	<b>GOST (option)</b> Metrology, measurement technology	Russia
	<b>KazInMetr (option)</b> Metrology, measurement technology	Kazakhstan
-	<b>MTSCHS (option)</b> Permission for commissioning	Kazakhstan
	<b>BelGIM (option)</b> Metrology, measurement technology	Belarus
	<b>Uzstandard (option)</b> Metrology, measurement technology	Uzbekistan
	<b>UkrSEPRO (option)</b> Metrology, measurement technology	Ukraine
-	<b>CPA (option)</b> Metrology, measurement technology	China
	<b>KCS (KOSHA) (option)</b> Hazardous areas - Ex i Zone 1 gas [Ex ia IIC T6]	South Korea
-	<b>CRN</b> Safety (e.g. electr. safety, overpressure, ...)	Canada

## Certificates (option)

- 2.2 test report per EN 10204  
(e.g. state-of-the-art manufacturing, material proof, indication accuracy)
- 3.1 inspection certificate per EN 10204  
(e.g. material proof for wetted metal parts, indication accuracy)
- Others on request

Approvals and certificates, see website

## Dimensions in mm

### Standard version

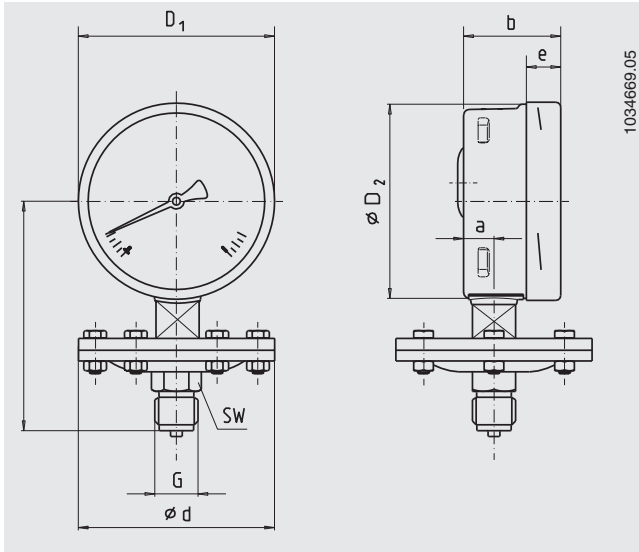

NS	Scale range	Dimensions in mm									Weight in kg
	in bar	d	a	b	$D_1$	$D_2$	e	G	h ±2	SW	
100	≤ 0.25	160	15.5	49.5	101	99	17.5	G ½ B	119	22	2.50
160	≤ 0.25	160	15.5	49.5	161	159	17.5	G ½ B	149	22	2.90
100	> 0.25	100	15.5	49.5	101	99	17.5	G ½ B	117	22	1.30
160	> 0.25	100	15.5	49.5	161	159	17.5	G ½ B	147	22	1.70

Process connection per EN 837-3 / 7.3

## Ordering information

Model / Nominal size / Scale range / Process connection / Connection location / Options

© 10/2008 WIKA Alexander Wiegand SE & Co. KG, all rights reserved.  
The specifications given in this document represent the state of engineering at the time of publishing.  
We reserve the right to make modifications to the specifications and materials.

